

Work Plus

by A S P L U N D

vol.4

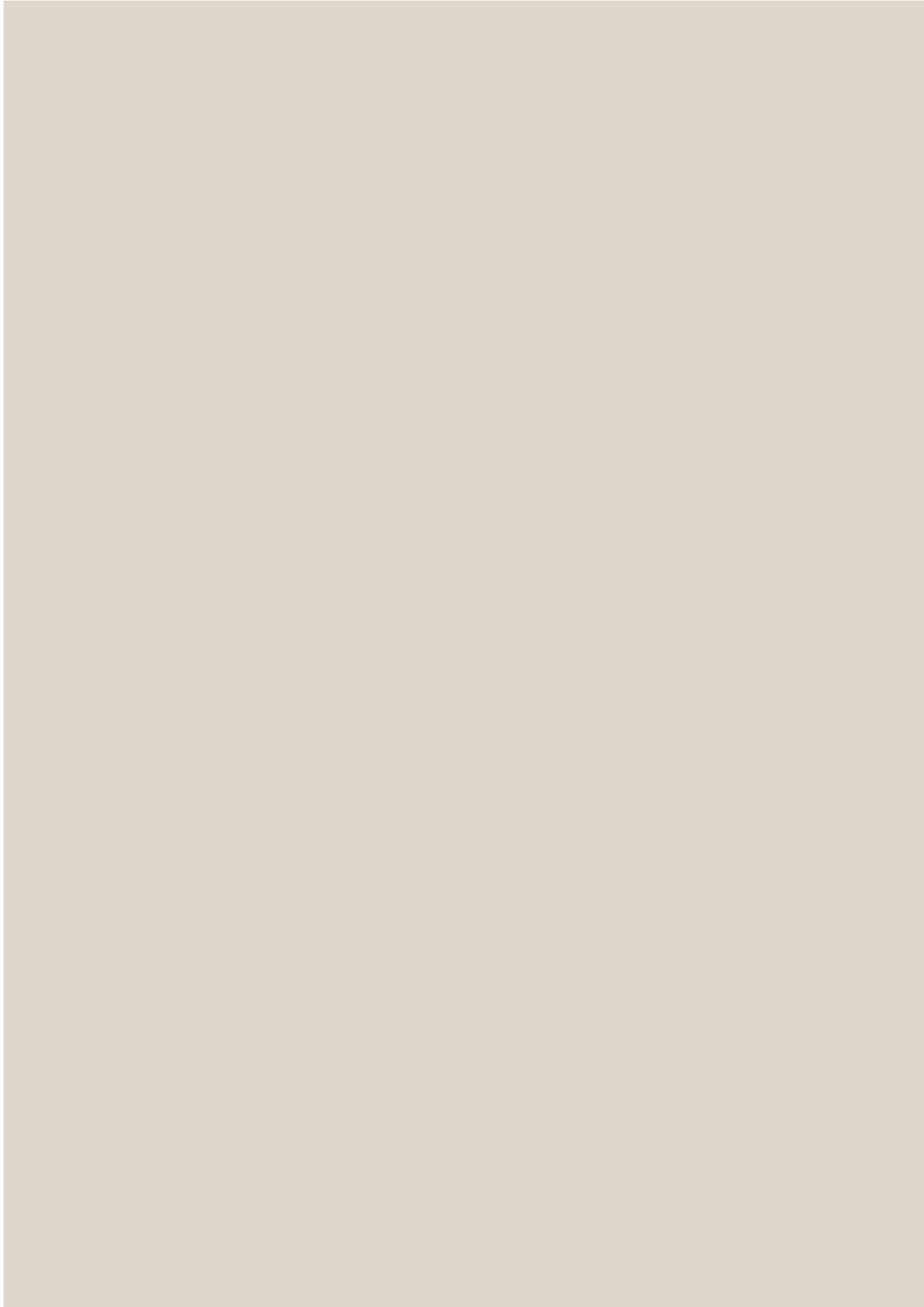

CONTENTS

FLEX-WIZ

CHAIR	04
DESK	22
STORAGE / SHELF	42
ACCESSORY	50
BOOTH	56

BASED-WIZ

SOFA	64
CHAIR	66
PERSONAL DESK / SOFA / STOOL	80
MOBILE / SWALLOW DESK	88
STORAGE	90
ACCESSORY	92

And-PluS

EMU	96
VINCENT SHEPPARD	102
DAREELS	108
JOURNAL STANDARD FURNITURE	112
Work Plus Sustainable	122
PHOTO INDEX	130

 Outdoor

 Stackable

 Sustainable

FLEX-WIZ

働き方をめぐる環境や価値観が著しく変化する時代。

価値観は多様化し、働き方には場所や時間にとらわれない様々な選択肢が生まれました。

FLEX-WIZ(フレックスウィズ)シリーズは、変化に対する柔軟性に富んだラインナップを有しており、変わりゆく時や価値の中でも、その瞬間に寄り添います。



Oriental green



Granite grey

MARBRIC CHAIR

マーブリック チェア

DESIGNED by CLAUDIO BELLINI

Code 285986 (Oriental green) 285979 (Granite grey)
Size W680 D680 H1080~1250 SH440~510 AH610~740
Material Fabric, Nylon, Polypropylene, Aluminum, PU caster
Price ¥72,000 (税込¥79,200)
※組立式

FLEX-WIZ



シート
前後40mm調節可能



ロッキング
角度4段階固定 / 強弱調節可能



ヘッドレスト
上下100mm調節可能



アーム
前後40mm・左右50mm・上下70mm
調節可能



ランバーサポート
上下50mm調節可能



VIVY CHAIR - main body

ヴィヴィー チェア

DESIGNED by CLAUDIO BELLINI

Code 286679 (Black) 286907 (Grey)
 Size W680 D680 H1100~1270 SH435~505 AH640~770 (Full option)
 Material Fabric, Nylon, Polypropylene, Aluminum, PU caster
 Price ¥56,000 (税込¥61,600)
 ※組立式



Black



Grey



OPTION - HEADREST

Size 286884 (Black) 286914 (Grey)
 Material ¥5,000 (税込¥5,500)



OPTION - ARMREST

Size 286891 (Black) 286921 (Grey)
 Material ¥8,000 (税込¥8,800)

FLEX-WIZ



シート
前後40mm調節可能



ロッキング
角度4段階固定 / 強弱調節可能



ヘッドレスト
上下100mm調節可能



アーム
前後40mm・左右50mm可動
上下70mm調節可能



ランバーサポート
上下50mm調節可能



FLEX-WIZ



White



Black



ロッキング
強弱調節可能

PLUME CHAIR - main body

プレミアム チェア

Code 286938 (White) 286952 (Black)
Size W630 D630 H970~1040 SH440~510 AH630~760 (Full option size)
Material Fabric, Nylon, Polypropylene, PU caster
Price ¥36,000 (税込¥39,600)

※組立式



OPTION - ARMREST

Size 286945 (White) 286969 (Black)
Material ¥7,000 (税込¥7,700)

※前後40mm・左右50mm・上下70mm調節可能



OCUS CHAIR

オーカス チェア

DESIGNED by CLAUDIO BELLINI

Code 286044
Size W580 D580 H770~860 SH420~510
Material PU leather, Polypropylene, PU caster
Price ¥42,000 (税込¥46,200)

※組立式



FLEX-WIZ





Pea green



Dove grey



バックレスト
上下30mm調節可能

COPPO HIGH CHAIR

コッポ ハイ チェア

Code 285993 (Pea green) 286013 (Dove grey)

Size W590 D590 H820~1050 SH530~730

Material Fabric, Nylon, PU caster

Price ¥45,000 (税込¥49,500)

※組立式

※フットステップ上下調節可能





FLEX-WIZ





ロッキング
角度5段階固定 / 強弱調節可能

LIAN CHAIR

ライアン チェア

Code 286075
Size W670 D670 H1185~1275 SH460~520 AH600~660
Material Cow leather (Inside), PU leather (Outside), Aluminum, PU caster
Price ¥180,000 (税込¥198,000)

※組立式



ヘッドレスト
上下30mm調節可能



FLEX-WIZ



ロッキング
角度4段階固定 / 強弱調節可能

RONAL CHAIR

ロナル チェア

Code 286082

Size W670 D670 H1235~1295 SH460~520 AH630~690

Material Cow leather (Inside), PU leather (Outside), Aluminum, PU caster

Price ¥120,000 (税込¥132,000)

※組立式



FLEX-WIZ



FLEX-WIZ



FLEX-WIZ FREE ADDRESS DESK LEG VARIATION

OAK WOOD



END LEG



CENTER LEG

END LEG

Code 278513
 Size W580 D1000 H690
 Price ¥57,000 (税込¥62,700)

CENTER LEG

Code 278506
 Size W720 D850 H690
 Price ¥63,000 (税込¥69,300)

STEEL - standard color -



Black



White



END LEG (Black)



CENTER LEG (White)

END LEG

Code 289359 (Black) 289366 (White)
 Size W580 D1000 H690
 Price ¥57,000 (税込¥62,700)

CENTER LEG

Code 289373 (Black) 289380 (White)
 Size W720 D850 H690
 Price ¥63,000 (税込¥69,300)

STEEL - selected color -



Grey green



Dark blue



Military green



END LEG (Grey green)



CENTER LEG (Dark blue)

END LEG

Code 285542 (Grey green) 285559 (Dark blue)
 285566 (Military green)
 Size W580 D1000 H690
 Price ¥64,000 (税込¥70,400)

CENTER LEG

Code 285573 (Grey green) 286419 (Dark blue)
 286426 (Military green)
 Size W720 D850 H690
 Price ¥68,000 (税込¥74,800)

FLEX-WIZ FREE ADRESS DESK

SET PATTERN ※組立式



Table top : WP-FA-2400-1200-SB-A

Size W2400 D1200 H720
Top Linoleum (Smoky blue)
Edge ABS
Leg Oak wood
Price ¥344,000 (税込¥378,400) ⇨



Table top : WP-FA-2400-1200-DB-A

Size W2400 D1200 H720
Top Melamine (Dark brown)
Edge ABS
Leg Steel (Black)
Price ¥282,000 (税込¥310,200)



Table top : WP-FA-2400-1200-PB-A

Size W2400 D1200 H720
Top Linoleum (Pebble)
Edge ABS
Leg Steel (White)
Price ¥344,000 (税込¥378,400) ⇨



Table top : WP-FA-2400-1200-CH-A

Size W2400 D1200 H720
Top Linoleum (Charcoal)
Edge ABS
Leg Steel (Grey green)
Price ¥358,000 (税込¥393,800) ⇨



Table top : WP-FA-2400-1200-WH-A

Size W2400 D1200 H720
Top Melamine (White)
Edge ABS
Leg Steel (Dark blue)
Price ¥296,000 (税込¥325,600)



Table top : WP-FA-2400-1200-NA-A

Size W2400 D1200 H720
Top Melamine (Natural)
Edge ABS
Leg Steel (Military green)
Price ¥296,000 (税込¥325,600)



Table top : WP-FA-2400-1200-OL-A × 2pcs

Size W4800 D1200 H720
Top LinoIeum (Olive)
Edge ABS
Leg Oak wood
Price ¥637,000 (税込¥700,700) ↩



Table top : WP-FA-2400-1200-BK-M × 3pcs

Size W7200 D1200 H720
Top Melamine (Black)
Edge Melamine
Leg Steel (Black)
Price ¥744,000 (税込¥818,400)

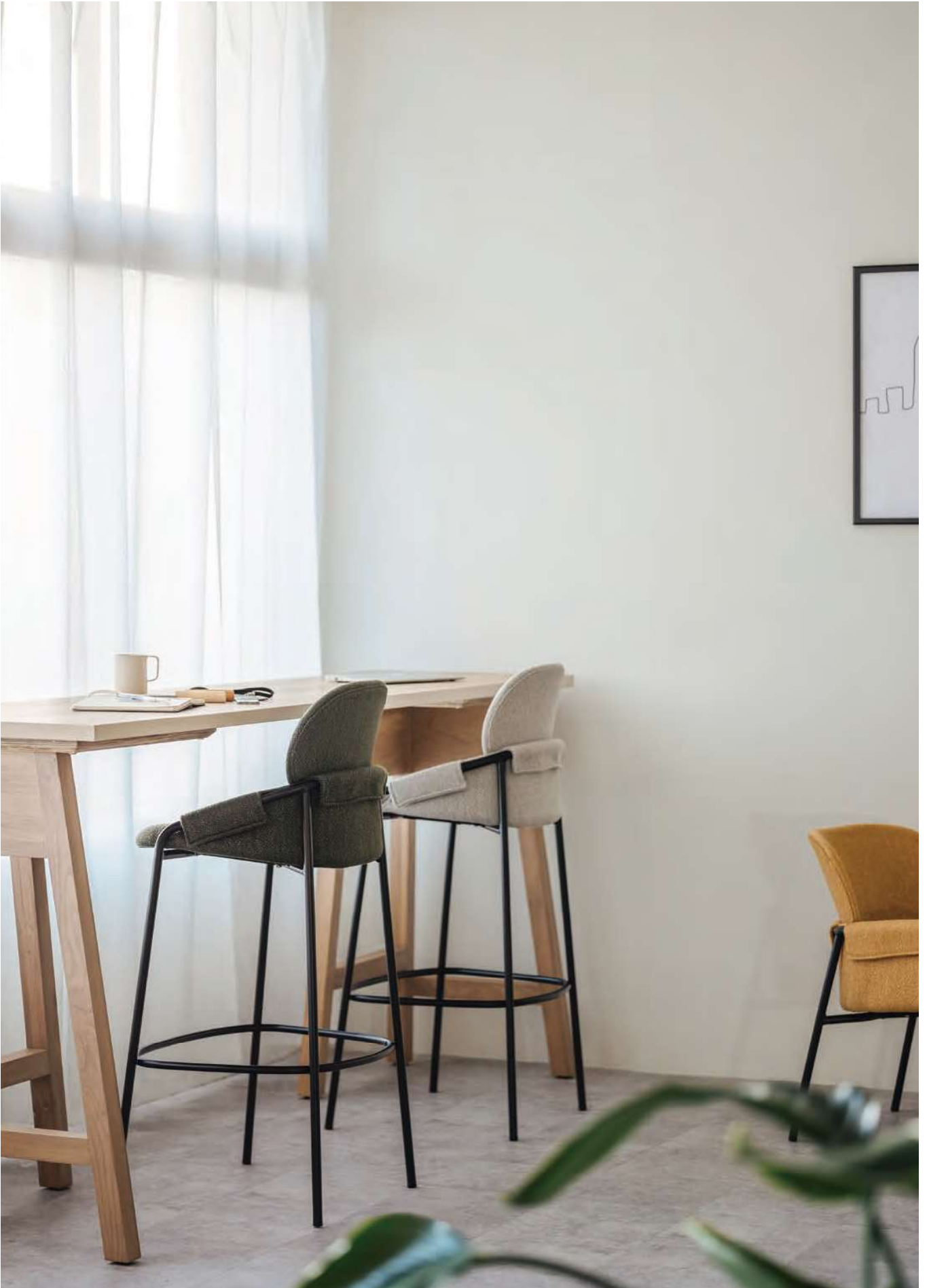

FLEX-WIZ



FLEX-WIZ MULTI DESK

FLEX-WIZ MULTI DESK TOP VARIATION

天板を3種類のバリエーションから、サイズを50mm単位 (W1200～ / D600～) でお選びいただけます。
ご注文の際は、下記の例を参考に、品番を用いて、サイズ・色をお知らせください。

品番: WP - MD - $\frac{\text{〇〇〇〇}}{\text{W寸}} - \frac{\text{〇〇〇}}{\text{D寸}} - \frac{\text{□□ - □}}{\text{色品番}}$ ※寸法はmm単位で記載をお願いします
※W・D寸いずれも50mm単位でのご注文をお願いいたします

MELAMINE×MELAMINE : W1200 D600 / Black をご注文の場合 = WP-MD-1200-600-BK-M
MELAMINE×ABS : W1250 D650 / Natural をご注文の場合 = WP-MD-1250-650-NA-A
LINOLEUM×ABS : W1400 D700 / Olive をご注文の場合 = WP-MD-1400-700-OL-A

MELAMINE×MELAMINE



MELAMINE×ABS



D \ W	1200	~1300	~1400
600	¥39,000	¥44,000	¥46,000
~700	¥51,000	¥56,000	¥58,000

※天板厚はすべて24mm、表示は税抜価格です
※色品番は各色()内をご参照ください

LINOLEUM×ABS



D \ W	1200	~1300	~1400
600	¥64,000	¥69,000	¥71,000
~700	¥78,000	¥83,000	¥85,000

※天板厚はすべて24mm、表示は税抜価格です
※色品番は各色()内をご参照ください

OPTION

配線キャップ 片開き(ブラシ有り)

Code 286631
Size W200 D50
Price ¥27,000 (税込¥29,700)
※配線トレー付き

配線キャップ 片開き(ブラシ無し)

Code 286648
Size W200 D50
Price ¥25,000 (税込¥27,500)
※配線トレー付き



FLEX-WIZ MULTI DESK LEG VARIATION

OAK WOOD



END LEG



CENTER LEG

END LEG

Code 283623
 Size W220 D590 H695
 Price ¥18,000 (税込¥19,800)

CENTER LEG

Code 283630
 Size W560 D590 H695
 Price ¥31,000 (税込¥34,100)

STEEL - standard color -



Black

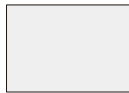

White



END LEG (Black)



CENTER LEG (White)

END LEG

Code 287775 (Black) 287782 (White)
 Size W220 D590 H695
 Price ¥33,000 (税込¥36,300)

CENTER LEG

Code 287829 (Black) 287836 (White)
 Size W560 D590 H695
 Price ¥39,000 (税込¥42,900)

STEEL - selected color -



Grey green



Dark blue



Military green



END LEG (Grey green)



CENTER LEG (Military green)

END LEG

Code 287799 (Grey green) 287805 (Dark blue)
 287812 (Military green)
 Size W220 D590 H695
 Price ¥42,000 (税込¥46,200)

CENTER LEG

Code 287843 (Grey green) 287850 (Dark blue)
 287867 (Military green)
 Size W560 D590 H695
 Price ¥48,000 (税込¥52,800)

FLEX-WIZ COUNTER DESK

FLEX-WIZ COUNTER DESK TOP VARIATION

天板を3種類のバリエーションから、サイズは50mm単位 (W寸のみ1600~) でお選びいただけます。
ご注文の際は、下記の例を参考に、品番を用いて、サイズ・色をお知らせください。

品番: WP - CD - $\frac{\text{〇〇〇〇}}{\text{W寸}} - \frac{\text{〇〇〇}}{\text{D寸}} - \frac{\text{□□ - □}}{\text{色品番}}$ ※寸法はmm単位で記載をお願いします
※W寸は50mm単位でのご注文をお願いいたします (D寸は600mmのみ)

MELAMINE×MELAMINE : W1600 D600 / Black をご注文の場合 = WP-CD-1600-600-BK-M
MELAMINE×ABS : W2050 D600 / Natural をご注文の場合 = WP-CD-2050-600-NA-A
LINOLEUM×ABS : W2400 D600 / Olive をご注文の場合 = WP-CD-2400-600-OL-A

MELAMINE×MELAMINE



MELAMINE×ABS



D \ W	1600	~1800	~2000	~2200	~2400
600	¥69,000	¥71,000	¥98,000	¥102,000	¥105,000

※天板厚はすべて30mm、表示は税抜価格です
※色品番は各色()内をご参照ください

LINOLEUM×ABS



D \ W	1600	~1800	~2000	~2200	~2400
600	¥106,000	¥108,000	¥115,000	¥119,000	¥122,000

※天板厚はすべて30mm、表示は税抜価格です
※色品番は各色()内をご参照ください

OPTION

配線キャップ 片開き(ブラシ有り)

Code 286631
Size W200 D50
Price ¥27,000 (税込¥29,700)
※配線トレイ付き

配線キャップ 片開き(ブラシ無し)

Code 286648
Size W200 D50
Price ¥25,000 (税込¥27,500)
※配線トレイ付き



FLEX-WIZ COUNTER DESK LEG VARIATION

OAK WOOD



END LEG



CENTER LEG

END LEG

Code 285825
Size W605 D550 H970
Price ¥56,000 (税込¥61,600)
※2台セット価格(左右各脚1台入り)

CENTER LEG

Code 285832
Size W720 D450 H970
Price ¥35,000 (税込¥38,500)

STEEL - standard color -



Black

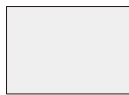

White



END LEG (Black)



CENTER LEG (White)

END LEG

Code 287676 (Black) 287683 (White)
Size W605 D550 H970
Price ¥84,000 (税込¥92,400)
※2台セット価格(左右各脚1台入り)

CENTER LEG

Code 287720 (Black) 287737 (White)
Size W720 D450 H970
Price ¥44,000 (税込¥48,400)

STEEL - selected color -



Grey green



Dark blue



Military green



END LEG (Dark blue)



CENTER LEG (Military green)

END LEG

Code 287690 (Grey green) 287706 (Dark blue)
287713 (Military green)
Size W605 D550 H970
Price ¥98,000 (税込¥107,800)
※2台セット価格(左右各脚1台入り)

CENTER LEG

Code 287744 (Grey green) 287751 (Dark blue)
287768 (Military green)
Size W720 D450 H970
Price ¥51,000 (税込¥56,100)

FLEX-WIZ MULTI DESK

SET PATTERN ※組立式



Table top : WP-MD-1200-600-SB-A

Size W1200 D600 H720
 Top Linoleum (Smoky blue)
 Edge ABS
 Leg Oak wood
 Price ¥100,000 (税込¥110,000) ⇨



Table top : WP-MD-1200-600-WH-A

Size W1200 D600 H720
 Top Melamine (White)
 Edge ABS
 Leg Steel (Black)
 Price ¥105,000 (税込¥115,500)



Table top : WP-MD-1200-600-PB-A

Size W1200 D600 H720
 Top Linoleum (Pebble)
 Edge ABS
 Leg Steel (White)
 Price ¥130,000 (税込¥143,000) ⇨



Table top : WP-MD-1200-600-OL-A

Size W1200 D600 H720
 Top Linoleum (Olive)
 Edge ABS
 Leg Steel (Grey green)
 Price ¥148,000 (税込¥162,800) ⇨



Table top : WP-MD-1200-600-MR-A

Size W1200 D600 H720
 Top Linoleum (Mushroom)
 Edge ABS
 Leg Steel (Dark blue)
 Price ¥148,000 (税込¥162,800) ⇨



Table top : WP-MD-1200-600-BK-A

Size W1200 D600 H720
 Top Melamine (Black)
 Edge ABS
 Leg Steel (Military green)
 Price ¥123,000 (税込¥135,300)

Size W2400 D600 H720
 Top Linoleum (Smoky blue)
 Melamine (Natural)
 Edge ABS
 Leg Oak wood
 Price ¥170,000 (税込¥187,000) ⇨



Table top : WP-MD-1200-600-SB-A / WP-MD-1200-600-NA-A

FLEX-WIZ COUNTER DESK

SET PATTERN ※組立式



Table top : WP-CD-2000-600-BK-A

Size W2000 D600 H1000
 Top Melamine (Black)
 Edge ABS
 Leg Oak wood
 Price ¥154,000 (税込¥169,400)



Table top : WP-CD-2000-600-WH-A

Size W2000 D600 H1000
 Top Melamine (White)
 Edge ABS
 Leg Steel (Black)
 Price ¥182,000 (税込¥200,200)



Table top : WP-CD-2000-600-OL-A

Size W2000 D600 H1000
 Top Linoleum (Olive)
 Edge ABS
 Leg Steel (White)
 Price ¥199,000 (税込¥218,900) ⇨



Table top : WP-CD-2000-600-SB-A

Size W2000 D600 H1000
 Top Linoleum (Smoky blue)
 Edge ABS
 Leg Steel (Grey green) ⇨
 Price ¥213,000 (税込¥234,300)



Table top : WP-CD-2000-600-NA-A

Size W2000 D600 H1000
 Top Melamine (Natural)
 Edge ABS
 Leg Steel (Dark blue)
 Price ¥196,000 (税込¥215,600)



Table top : WP-CD-2000-600-CH-A

Size W2000 D600 H1000
 Top Linoleum (Charcoal)
 Edge ABS
 Leg Steel (Military green) ⇨
 Price ¥213,000 (税込¥234,300)



Table top : WP-CD-2000-600-WH-A / WP-CD-2000-600-BK-A

Size W4000 D600 H1000
 Top Melamine (White / Black)
 Edge ABS
 Leg Oak wood
 Price ¥287,000 (税込¥315,700)



Table top : WP-CD-2000-600-PB-A x 2pcs

Size W4000 D600 H1000
 Top Linoleum (Pebble)
 Edge ABS
 Leg Steel (Grey green) ⇨
 Price ¥379,000 (税込¥416,900)

FLEX-WIZ FUNCTIONAL DESK



SET PATTERN ※組立式

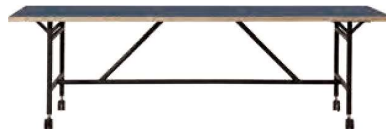

Table top : WP-FD-2400-1200-SB-A

Size W2400 D1200 H720
 Top Linoleum (Smoky blue)
 Edge ABS
 Leg Steel (Black)
 Price ¥374,000 (税込¥411,400) ⇨



Table top : WP-FD-2400-1200-NA-A

Size W2400 D1200 H720
 Top Melamine (Natural)
 Edge ABS
 Leg Steel (Grey green)
 Price ¥322,000 (税込¥354,200)



Table top : WP-FD-2400-1200-OL-A

Size W2400 D1200 H720
 Top Linoleum (Olive)
 Edge ABS
 Leg Steel (White)
 Price ¥374,000 (税込¥411,400) ⇨



Table top : WP-FD-2400-1200-DB-A

Size W2400 D1200 H720
 Top Melamine (Dark brown)
 Edge ABS
 Leg Steel (Dark blue)
 Price ¥322,000 (税込¥354,200)



Table top : WP-FD-2400-1200-CH-A

Size W2400 D1200 H720
 Top Linoleum (Charcoal)
 Edge ABS
 Leg Steel (Military green)
 Price ¥384,000 (税込¥422,400) ⇨

FLEX-WIZ FUNCTIONAL DESK TOP VARIATION

天板を3種類のバリエーションから、お選びいただけます。
ご注文の際は、下記の例を参考に、品番を用いて、色をお知らせください

品番：WP - FD - ○○○○ - ○○○○ - □□-□ ※寸法はmm単位で記載をお願いします
W寸 D寸 色品番

MELAMINE×MELAMINE：W2400 D1200 / Black をご注文の場合 = WP-FD-2400-1200-BK-M
 MELAMINE×ABS：W2400 D1200 / Natural をご注文の場合 = WP-FD-2400-1200-NA-A
 LINOLEUM×ABS：W2400 D1200 / Olive をご注文の場合 = WP-FD-2400-1200-OL-A

MELAMINE×MELAMINE



Size W2400 D1200 t30
 Price ¥153,000 (税込¥168,300) ※色品番は各色()内をご参照ください

MELAMINE×ABS



LINOLEUM×ABS



Size W2400 D1200 t30
 Price ¥215,000 (税込¥236,500) ※色品番は各色()内をご参照ください

OPTION

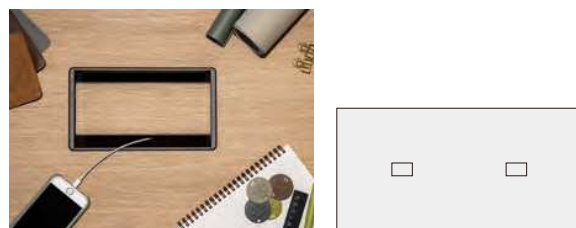

※配線キャップをご希望の場合は、P.22よりご選定ください
 ※本製品の配線キャップ取付位置は、所定の2ヶ所のみとなります

FLEX-WIZ FUNCTIONAL DESK LEG VARIATION

STEEL - standard color -



Code 287621 (Black)
 287638 (White)
 Size W2150 D1100 H690
 Price ¥159,000 (税込¥174,900)



Black

STEEL - selected color -

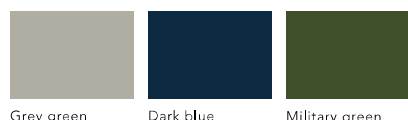

Code 287645 (Grey green)
 287652 (Dark blue)
 287669 (Military green)
 Size W2150 D1100 H690
 Price ¥169,000 (税込¥185,900)



Military green

FLEX-WIZ HUDDLE CASTER DESK



SET PATTERN ※組立式



Table top : WP-HC-1200-1200-DB-A

Size W1200 D1200 H720
 Top Melamine (Dark brown)
 Edge ABS
 Leg Steel (Black)
 Price ¥139,000 (税込¥152,900)



Table top : WP-HC-1200-1200-MR-A

Size W1200 D1200 H720
 Top Linoleum (Mushroom)
 Edge ABS
 Leg Steel (White)
 Price ¥189,000 (税込¥207,900) ⇨



Table top : WP-HC-1200-1200-NA-A

Size W1200 D1200 H720
 Top Melamine (Natural)
 Edge ABS
 Leg Steel (Grey green)
 Price ¥149,000 (税込¥163,900)



Table top : WP-HC-1200-1200-PB-A

Size W1200 D1200 H720
 Top Linoleum (Pebble)
 Edge ABS
 Leg Steel (Dark blue)
 Price ¥199,000 (税込¥218,900) ⇨



Table top : WP-HC-1200-1200-OL-A

Size W1200 D1200 H720
 Top Linoleum (Olive)
 Edge ABS
 Leg Steel (Military green)
 Price ¥199,000 (税込¥218,900) ⇨

FLEX-WIZ HUDDLE CASTER DESK TOP VARIATION

天板を3種類のバリエーションから、サイズは4種類よりお選びいただけます。
ご注文の際は、下記の例を参考に、品番を用いて、色をお知らせください。

品番: WP - HC - $\frac{\square\square\square}{W寸}$ - $\frac{\square\square\square}{D寸}$ - $\frac{\square\square}{色番}$ ※寸法は3~4桁のmm単位で記載をお願いします

MELAMINE×MELAMINE : W900 D900 / Black をご注文の場合 = WP-HC-900-900-BK-M
 MELAMINE×ABS : W1000 D1000 / Natural をご注文の場合 = WP-HC-1000-1000-NA-A
 LINOLEUM×ABS : W1200 D1200 / Olive をご注文の場合 = WP-HC-1200-1200-OL-A

MELAMINE×MELAMINE



MELAMINE×ABS



LINOLEUM×ABS



OPTION



※配線キャップをご希望の場合は、P.22よりご選定ください
 ※本製品の配線キャップ取付位置は、所定の1ヶ所のみとなります

MTA \ SIZE	□900	□1000	□1100	□1200
Melamine	¥45,000	¥65,000	¥67,000	¥70,000
Linoleum	¥83,000	¥115,000	¥117,000	¥120,000

※天板厚はすべて30mm、表示は税抜価格です
 ※色番は各色()内をご参照ください

FLEX-WIZ HUDDLE CASTER DESK LEG VARIATION

STEEL - standard color -



STEEL - selected color -

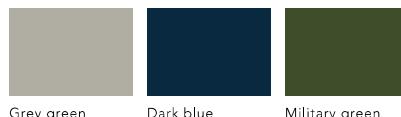

COL \ SIZE	Leg for □900	Leg for □1000	Leg for □1100	Leg for □1200
Standard	¥66,000	¥67,000	¥68,000	¥69,000
Selected	¥76,000	¥77,000	¥78,000	¥79,000

※高さはすべて690mm、表示価格は税抜価格です

Code

Leg for □900	287416 (Black)	287423 (White)	287430 (Grey green)	287447 (Dark blue)	287454 (Military green)
Leg for □1000	287461 (Black)	287478 (White)	287485 (Grey green)	287492 (Dark blue)	287508 (Military green)
Leg for □1100	287515 (Black)	287522 (White)	287539 (Grey green)	287546 (Dark blue)	287553 (Military green)
Leg for □1200	283395 (Black)	285528 (White)	287560 (Grey green)	287577 (Dark blue)	287584 (Military green)

FLEX-WIZ BOOTH MEET DESK



SET PATTERN ※組立式



Table top : WP-BM-1400-800-BK-A

Size W1400 D800 H720
 Top Melamine (Black)
 Edge ABS
 Leg Steel (Black)
 Price ¥119,000 (税込¥130,900)



Table top : WP-BM-1400-800-DB-A

Size W1400 D800 H720
 Top Melamine (Dark brown)
 Edge ABS
 Leg Steel (White)
 Price ¥119,000 (税込¥130,900)



Table top : WP-BM-1400-800-WH-A

Size W1400 D800 H720
 Top Melamine (White)
 Edge ABS
 Leg Steel (Grey green)
 Price ¥129,000 (税込¥141,900)



Table top : WP-BM-1400-800-OL-A

Size W1400 D800 H720
 Top Linoeum (Olive)
 Edge ABS
 Leg Steel (Dark blue)
 Price ¥158,000 (税込¥173,800) ⇐



Table top : WP-BM-1400-800-SB-A

Size W1400 D800 H720
 Top Linoeum (Smoky blue)
 Edge ABS
 Leg Steel (Military green)
 Price ¥158,000 (税込¥173,800) ⇐

FLEX-WIZ BOOTH MEET DESK TOP VARIATION

天板を3種類のバリエーションから、お選びいただけます。
 ご注文の際は、下記の例を参考に、品番を用いて、色をお知らせください

品番：WP - BM - ○○○○ - ○○○ - □□ - □ ※寸法はmm単位で記載をお願いします
 W寸 D寸 色品番

MELAMINE×MELAMINE：W1400 D800 / Black をご注文の場合 = WP-BM-1400-800-BK-M
 MELAMINE×ABS：W1400 D800 / Natural をご注文の場合 = WP-BM-1400-800-NA-A
 LINOLEUM×ABS：W1400 D800 / Olive をご注文の場合 = WP-BM-1400-800-OL-A

MELAMINE×MELAMINE



Black (BK-M) White (WH-M) Natural (NA-M) Dark brown (DB-M)

Size W1400 D800 t30 ※色品番は各色 () 内をご参照ください
 Price ¥70,000 (税込¥77,000) ※配線キャップの取付は不可です

MELAMINE×ABS



Black (BK-A) White (WH-A) Natural (NA-A) Dark brown (DB-A)

Size W1400 D800 t30 ※色品番は各色 () 内をご参照ください
 Price ¥70,000 (税込¥77,000) ※配線キャップの取付は不可です

LINOLEUM×ABS ⇄



Olive (OL-A) Smoky blue (SB-A) Charcoal (CH-A) Pebble (PB-A) Mushroom (MR-A)

Size W1400 D800 t30 ※色品番は各色 () 内をご参照ください
 Price ¥99,000 (税込¥108,900) ※配線キャップの取付は不可です

FLEX-WIZ BOOTH MEET DESK LEG VARIATION

STEEL - standard color -



Code 283449 (Black) 285535 (White)

Size W1325 D585 H690

Price ¥49,000 (税込¥53,900)

STEEL - selected color -

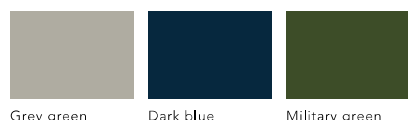

Code 287591 (Grey green) 287607 (Dark blue) 287614 (Military green)

Size W1325 D585 H690

Price ¥59,000 (税込¥64,900)



FLEX-WIZ



FLEX-WIZ STORAGE

FLEX-WIZ STORAGE BODY COLOR VARIATION



FLEX-WIZ STORAGE BODY TYPE VARIATION

※LEGとセットでのみの販売です。BODY単体での販売はございません。

OPEN 800

Size W800 D400 H900
Material Steel
※可動棚付き



Code / Price

White 289175 / ¥38,000 (税込¥41,800)
Black 289182 / ¥43,000 (税込¥47,300)
Olive 287874 / ¥51,000 (税込¥56,100)
Greige 287911 / ¥51,000 (税込¥56,100)

OPEN 1180

Size W1180 D400 H900
Material Steel
※可動棚付き



Code / Price

White 289250 / ¥50,000 (税込¥55,000)
Black 289267 / ¥57,000 (税込¥62,700)
Olive 287881 / ¥62,000 (税込¥68,200)
Greige 287928 / ¥62,000 (税込¥68,200)

4 DOOR

Size W800 D400 H900
Material Steel
※ダイヤル錠付き



Code / Price

White 288451 / ¥87,000 (税込¥95,700)
Black 288468 / ¥93,000 (税込¥102,300)
Olive 287898 / ¥106,000 (税込¥116,600)
Greige 287935 / ¥106,000 (税込¥116,600)

6 DOOR

Size W1180 D400 H900
Material Steel
※ダイヤル錠付き



Code / Price

White 288512 / ¥134,000 (税込¥147,400)
Black 288529 / ¥144,000 (税込¥158,400)
Olive 287904 / ¥158,000 (税込¥173,800)
Greige 287942 / ¥158,000 (税込¥173,800)

FLEX-WIZ STORAGE LEG VARIATION

※BODYとセットでのみの販売です。LEG単体での販売はございません。

OAK WOOD 790

Code 289113
Size W790 D390 H350
Material Oak wood
Price ¥24,000 (税込¥26,400)

OAK WOOD 1170

Code 289144
Size W1170 D390 H350
Material Oak wood
Price ¥30,000 (税込¥33,000)



STEEL WHITE 790

Code 289168
Size W790 D390 H350
Material Steel
Price ¥24,000 (税込¥26,400)

STEEL WHITE 1170

Code 289137
Size W1170 D390 H350
Material Steel
Price ¥30,000 (税込¥33,000)

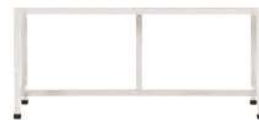

STEEL BLACK 790

Code 289151
Size W790 D390 H350
Material Steel
Price ¥24,000 (税込¥26,400)

STEEL BLACK 1170

Code 289120
Size W1170 D390 H350
Material Steel
Price ¥30,000 (税込¥33,000)



SET PATTERN ※組立式



Size W1180 D400 H1250
 Body Open 1180 (White)
 Leg Steel (Black)
 Price ¥80,000 (税込¥88,000)



Size W1180 D400 H1250
 Body 6 door (White)
 Leg Oak wood
 Price ¥164,000 (税込¥180,400)



Size W800 D400 H1250
 Body 4 door (White)
 Leg Steel (White)
 Price ¥111,000 (税込¥122,100)



Size W1180 D400 H1250
 Body Open 1180 (Black)
 Leg Steel (Black)
 Price ¥87,000 (税込¥95,700)



Size W1180 D400 H1250
 Body 6 door (Black)
 Leg Oak wood
 Price ¥174,000 (税込¥191,400)



Size W800 D400 H1250
 Body 4 door (Black)
 Leg Steel (White)
 Price ¥117,000 (税込¥128,700)



Size W1180 D400 H1250
 Body Open 1180 (Olive)
 Leg Steel (Black)
 Price ¥92,000 (税込¥101,200)



Size W1180 D400 H1250
 Body 6 door (Olive)
 Leg Oak wood
 Price ¥188,000 (税込¥206,800)



Size W800 D400 H1250
 Body 4 door (Olive)
 Leg Steel (White)
 Price ¥130,000 (税込¥143,000)



Size W1180 D400 H1250
 Body Open 1180 (Greige)
 Leg Steel (Black)
 Price ¥92,000 (税込¥101,200)



Size W1180 D400 H1250
 Body 6 door (Greige)
 Leg Oak wood
 Price ¥188,000 (税込¥206,800)



Size W800 D400 H1250
 Body 4 door (Greige)
 Leg Steel (White)
 Price ¥130,000 (税込¥143,000)



FLEX-WIZ



FLEX-WIZ CABINET 5 TIER

フレックスウィズ キャビネット 5 ティア

Code 284101
Size W1200 D400 H1940
Material Steel, Wood grain sheet, Oak wood
Price ¥215,000 (税込¥236,500)

※組立式
※可動棚・配線孔・アジャスター付き



FLEX-WIZ CABINET 3 TIER

フレックスウィズ キャビネット 3 ティア

Code 284118
Size W1200 D400 H1180
Material Steel, Wood grain sheet, Oak wood
Price ¥182,000 (税込¥200,200)

※組立式
※可動棚・配線孔・アジャスター付き



FLEX-WIZ PROD SHELF



3 TIER

Code 284385'
281544 (Frame)
282374 (Shelf board)

Size W800 D440 H1200
Material Steel, Melamine
Price ¥40,000 (税込¥44,000)

※Special price
※組立式



3 ADD ON

Code 284392'
281551 (Frame)
282374 (Shelf board)

Size W800 D440 H1200
Material Steel, Melamine
Price ¥32,000 (税込¥35,200)

※Special price
※組立式



4 TIER

Code 284361'
281629 (Frame)
282643 (Shelf board)

Size W800 D440 H1590
Material Steel, Melamine
Price ¥50,000 (税込¥55,000)

※Special price
※組立式

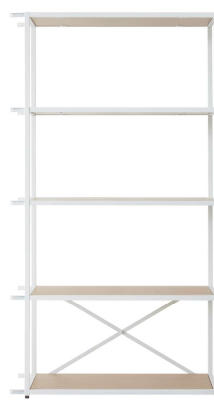

4 ADD ON

Code 284378'
281636 (Frame)
282643 (Shelf board)

Size W800 D440 H1590
Material Steel, Melamine
Price ¥42,000 (税込¥46,200)

※Special price
※組立式



5 TIER

Code 284347'
281711 (Frame)
281735 (Shelf board)

Size W800 D440 H1980
Material Steel, Melamine
Price ¥60,000 (税込¥66,000)

※Special price
※組立式

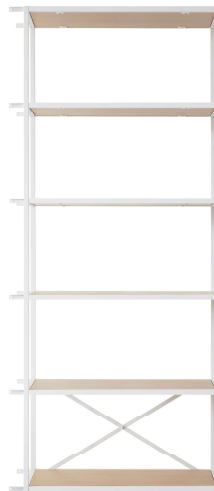

5 ADD ON

Code 284354'
281728 (Frame)
281735 (Shelf board)

Size W800 D440 H1980
Material Steel, Melamine
Price ¥52,000 (税込¥57,200)

※Special price
※組立式



OPTION

FLEX-WIZ PROD SHELF BACK PANEL ⇐⇒

フレックスウィズ プロッド シェルフ バック パネル

Code 284323 (Olive) 285054 (Smoky blue) 286532 (Charcoal)
285061 (Pebble) 286549 (Mushroom)

Size W757 D362 t21

Material Linoleum

Price ¥15,000 (税込¥16,500)

※Special price

※右図5色よりお選びください

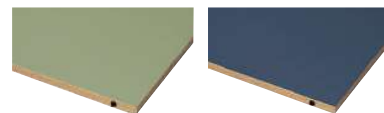

Olive

Smoky blue

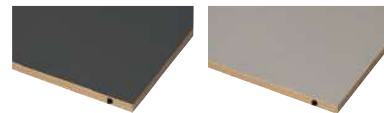

Charcoal

Pebble



Mushroom

FLEX-WIZ PROD SHELF SIDE PANEL ⇐⇒

フレックスウィズ プロッド シェルフ サイド パネル

Code 284330 (Olive) 285078 (Smoky blue) 286556 (Charcoal)
285085 (Pebble) 286563 (Mushroom)

Size W396 D362 t21

Material Linoleum

Price ¥10,000 (税込¥11,000)

※Special price

※右図5色よりお選びください

FLEX-WIZ PROD SHELF WRITING BACK PANEL

フレックスウィズ プロッド シェルフ ライティング バック パネル

Code 283678

Size W757 D362 t21

Material Melamine

Price ¥8,000 (税込¥8,800)

※Special price

※マグネットは使用できません

※サイズはバックパネル用のみ



Writing back panel

FLEX-WIZ PROD SHELF

SET PATTERN ※組立式



Size W800 D440 H1200
Body 3 TIER
Option Back panel (Writing / Olive / Smoky blue)
Side panel (Olive / Smoky blue / Pebble)



Size W800 D440 H1590
Body 4 TIER
Option Back panel (Writing / Olive / Pebble)
Side panel (Olive / Smoky blue / Pebble)



Size W800 D440 H1980
Body 5 TIER
Option Back panel (Writing / Olive / Smoky blue / Pebble)
Side panel (Olive / Smoky blue×2pcs / Pebble)







Smoky blue

FLEX-WIZ LINO DESK MAT

フレックスウィズ リノ デスク マット

Code 286587 (Olive) 286594 (Smoky blue) 286600 (Charcoal)
286617 (Pebble) 286624 (Mushroom)
Size W800 D440 t3
Material Linoleum, Rubber
Price ¥25,000 (税込¥27,500)



Olive



Smoky blue



Charcoal



Pebble



Mushroom



FLEX-WIZ REVIVER CUSHION ↩

フレックスウィズ リバイバー クッション

Code 286686 (Yellow) 286693 (Brown)
286709 (Green) 286716 (Charcoal grey)
Size W450 D450
Material Polyester
Price ¥15,000 (税込¥16,500)

※下図4色よりお選びください

※中材は海洋プラスチック再生綿です



FLEX-WIZ REVIVER CUSHION RECT ↩

フレックスウィズ リバイバー クッション レクト

Code 286723 (Yellow) 286730 (Brown)
286747 (Green) 286754 (Charcoal grey)
Size W600 D400
Material Polyester
Price ¥16,000 (税込¥17,600)

※下図4色よりお選びください

※中材は海洋プラスチック再生綿です



Yellow

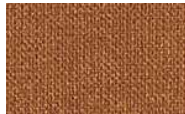

Brown



Green



Charcoal grey



中材には、世界的な環境問題である海洋プラスチックごみから作られた、Suprelle™blue (スープレルブルー)を採用しております。

カバー部分には、野菜や果実などの天然成分を活用して染め上げたファブリックを採用しており、植物原料ならではの美しさを有したクッションは、環境にも配慮した仕様となっております。



FLEX-WIZ



FLEX-WIZ DESKTOP PANEL FELT 1180

フレックスウィズ デスクトップ パネル フェルト 1180

Code 288888
Size W1180 D120 H440
Material Polyester, Oak wood
Price ¥14,000 (税込¥15,400)

※組立式



FLEX-WIZ DESKTOP PANEL FELT 590

フレックスウィズ デスクトップ パネル フェルト 590

Code 288864
Size W590 D120 H440
Material Polyester, Oak wood
Price ¥10,000 (税込¥11,000)

※組立式



FLEX-WIZ DESKTOP PANEL ACRYLIC 1180

フレックスウィズ デスクトップ パネル アクリル 1180

Code 288871
Size W1180 D115 H440
Material Acrylic, Oak wood
Price ¥14,000 (税込¥15,400)

※組立式



FLEX-WIZ DESKTOP PANEL ACRYLIC 590

フレックスウィズ デスクトップ パネル アクリル 590

Code 288857
Size W590 D115 H440
Material Acrylic, Oak wood
Price ¥10,000 (税込¥11,000)

※組立式



FLEX-WIZ WHITE BOARD L

フレックスウィズ ホワイト ボード L

Code 286433
Size W1200 D640 H1780
Material Steel, Oak wood, PVC
Price ¥68,000 (税込¥74,800)

※組立式





FLEX-WIZ



※詳細はお問い合わせください

FLEX-WIZ

COCOON BOOTH

コクーンブース

Material メイン素材：不燃シート
 外装素材：ガラス、メラミン、鍵（外 シリンダー錠 / 内 サムターン錠）
 内装素材：メラミン、タイルカーペット

※価格などの詳細はお問い合わせください
 ※国土交通大臣認定 不燃材料認定品使用
 ※PSE認証品

SIZE VARIATION

Small (Standing type)

Size (外寸) W1000 D1000 H2320
 Size (内寸) W910 D890 H1980
 Weight ≒185kg以下

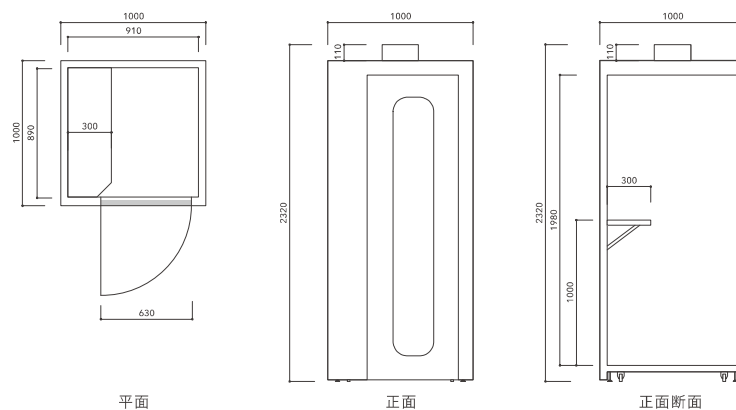

Medium

Size (外寸) W1100 D1100 H2320
 Size (内寸) W1010 D990 H1980
 Weight ≒185kg以下

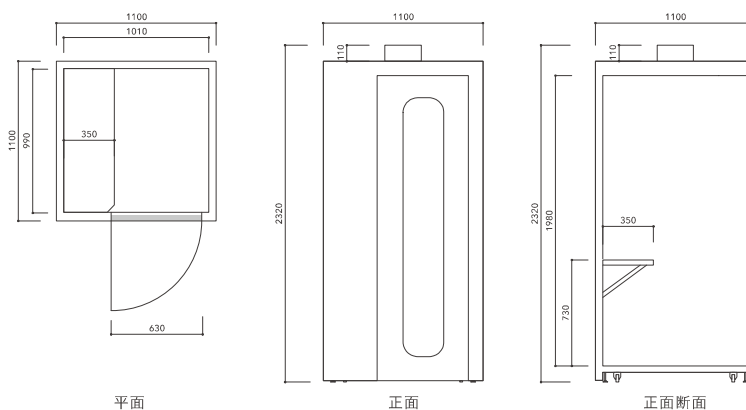

Large

Size (外寸) W1200 D1200 H2320
 Size (内寸) W1110 D1090 H1980
 Weight ≒185kg以下

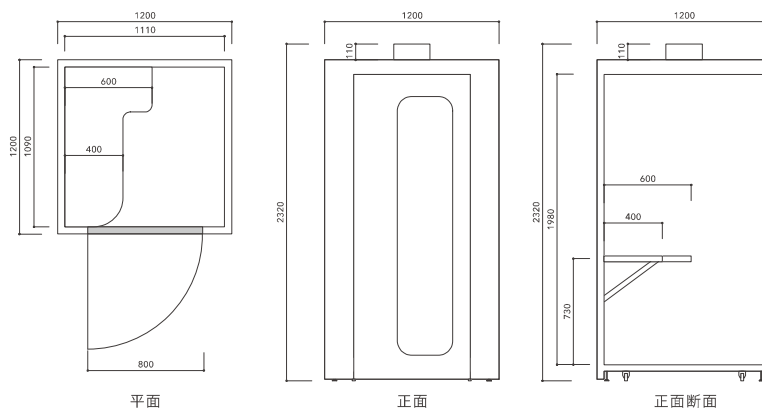

Green

Code
Small 284026
Medium 284033
Large 284040

Color spec
天板 Charcoal
換気 Black
コンセント Black
壁面フック Black
ハンドル / 鍵 Silver



Navy

Code
Small 284057
Medium 284064
Large 284071

Color spec
天板 Charcoal
換気 Black
コンセント Black
壁面フック Black
ハンドル / 鍵 Black



Pink

Code
Small 283937
Medium 283944
Large 283951

Color spec
天板 White
換気 White
コンセント White
壁面フック Bronze
ハンドル / 鍵 Bronze



COCOON BOOTH

COLOR VARIATION

S・M・Lの豊富な3サイズ展開、特徴的な5タイプのデザインが、様々な空間との調和を実現します。
天板・ハンドル・床材など細部にまでこだわったカラーリングは、より一層オフィス空間を彩ります。
ご注文の際は、ご希望のサイズ・カラーをお知らせください。



Beige

Code	
Small	283968
Medium	283975
Large	283982

Color spec	
天板	White
換気	White
コンセント	White
壁面フック	Bronze
ハンドル / 鍵	Bronze



Grey

Code	
Small	283999
Medium	284002
Large	284019

Color spec	
天板	Brown
換気	White
コンセント	White
壁面フック	Bronze
ハンドル / 鍵	Bronze



FLEX-WIZ



STANDARD PARTS

- ① LED ダウンライト × 1灯
- ② 換気扇 × 1台
- ③ 自動消火装置(放出型) × 1台
- ④ AC電源1口+スイッチ × 1箇所
- ⑤ AC電源1口+USB電源1口 × 1箇所
- ⑥ 壁面フック × 1箇所
- 火災報知器(電池式) × 1台
- アジャスター × 4箇所
- キャスター × 4箇所



OPTION PARTS

- ⑦ 吸音パネル Code 286570
- ⑧ 間接照明 Code 285146

※詳細はお問い合わせください

COCOON BOOTH



※Large仕様 / チェアは付属していません

FLEX-WIZ

BASED-WIZ

大切な時を紡ぐ特別な場所。

会話から繋がりを、集中から創造性を、憩いからやすらぎを。

多様な働き方を実現するための最適な空間を演出する、BASED-WIZ (ベースドウィズ) シリーズ。

幅広いデザイン・用途で構成された家具たちは、働くことを通じて、日常に彩りを添えます。



Left



Right

MALU-TUBE 2P SOFA

マルチューブ 2P ソファ

Code	285948 (Left) 285955 (Right)
Size	W1690 D830 H650 SH400
Material	Fabric, Steel
Price	¥120,000 (税込¥132,000)

※組立式



Left



Right

MALU-TUBE 1P SOFA

マルチューブ 1P ソファ

Code	285924 (Left) 285931 (Right)
Size	W1130 D830 H650 SH400
Material	Fabric, Steel
Price	¥78,000 (税込¥85,800)

※組立式







BASED-WIZ



Canary yellow



Ivy green



Sand beige

MAYUKU LOUNGE CHAIR

マユク ラウンジ チェア

DESIGNED by CLAUDIO BELLINI

Code 285894 (Canary yellow)

286105 (Ivy green)

285887 (Sand beige)

Size W700 D650 H680 SH350 AH520

Material Fabric, Steel

Price ¥42,000 (税込¥46,200)



Ivy green



Sand beige

MAYUKU ARM CHAIR

マユク アーム チェア

DESIGNED by CLAUDIO BELLINI

Code 286099 (Ivy green)

285863 (Sand beige)

Size W630 D540 H740 SH450 AH600

Material Fabric, Steel

Price ¥35,000 (税込¥38,500)



Ivy green



Sand beige

MAYUKU BAR STOOL

マユク バー スツール

DESIGNED by CLAUDIO BELLINI

Code 283258 (Ivy green)

283234 (Sand beige)

Size W570 D465 H1060 SH760 AH830

Material Fabric, Steel

Price ¥39,000 (税込¥42,900)





Light grey



Sand beige



Ivy green

HOAKA CHAIR

ホアカ チェア

Code 501765 (Light grey)
501758 (Sand beige)
501772 (Ivy green)
Size W545 D550 H780 SH485 AH690
Material Fabric, Steel
Price ¥26,000 (税込¥28,600)

※組立式
※スタッキング4脚まで可能





Light grey



Dark grey

KANO CASTER CHAIR

カノア キャスター チェア

Code 501307 (Light grey)
501789 (Dark grey)
Size W480 D545 H790 SH485
Material Fabric, Steel, PP caster
Price ¥24,000 (税込¥26,400)
※組立式



BASED-WIZ





Slate black



Ice grey

NORUN CHAIR

ノルン チェア

DESIGNED by CLAUDIO BELLINI

Code 285900 (Slate black) 285917 (Ice grey)

Size W495 D495 H805 SH455

Material Polypropylene, Plywood

Price ¥22,000 (税込¥24,200)

※スタッキング4脚まで可能







Ginger



Brown



Black

LEHUA CHAIR

レファ チェア

Code 501130 (Ginger) 501123 (Brown) 501093 (Black)

Size W590 D580 H790 SH485 AH650

Material Polypropylene, Beech wood

Price ¥26,000 (税込¥28,600)

※組立式



Mint green



Ginger



Red



Brown

OLU CHAIR

オル チェア

DESIGNED by CLAUDIO BELLINI

Code 501802 (Mint green)

501437 (Ginger)

501796 (Red)

501420 (Brown)

Size W480 D470 H800 SH470

Material Polypropylene

Price ¥19,000 (税込¥20,900)

※スタッキング4脚まで可能







Terra cotta



Mint



Greige

CORITO CHAIR

コリト チェア

Code 282572 (Terra cotta) 282589 (Mint) 282565 (Greige)

Size W615 D550 H790 SH460

Material PU leather, Steel, Nylon caster

Price ¥27,000 (税込¥29,700)

※スタッキング4脚まで可能



Grey



Black

MOONO CHAIR

モノ チェア

Code 282558 (Grey) 282541 (Black)

Size W630 D605 H810 SH450 AH670

Material Fabric, Steel, Nylon caster

Price ¥26,000 (税込¥28,600)

※折りたたみ可能



BASED-WIZ



LILO LOUNGE CHAIR

リロ ラウンジ チェア

DESIGNED by CLAUDIO BELLINI

Code 501505
Size W1000 D830 H1140 SH430
Material Fabric
Price ¥110,000 (税込¥121,000)



Light blue



Light grey



Beige

LAPULE 1P OTTOMAN

ラプレ 1P オットマン

Code 501840 (Light blue)
501857 (Light grey)
501833 (Beige)
Size W420 D420 H370
Material Fabric
Price ¥17,000 (税込¥18,700)



BASED-WIZ PERSONAL DESK

ベースドウィズ パーソナル デスク

Code 282664 (Ash) 282671 (Toffee)

Size W1000 D700 H1400 TH720

Material Fabric, Steel, Melamine

Price ¥87,000 (税込¥95,700)

※組立式



Ash



Toffee

BASED-WIZ



BASED-WIZ PERSONAL SOFA

ベースドウィズ パーソナル ソファ

Code 286297 (Ash) 286303 (Toffee)

Size W1000 D700 H1400 SH430

Material Fabric, Steel

Price ¥98,000 (税込¥107,800)

※組立式



Ash



Toffee





BASED-WIZ BOOTH SOFA

ベースドウィズ プース ソファ

Code 286310 (Ash) 286327 (Toffee)
Size W1400 D700 H1100 SH450
Material Fabric, Steel
Price ¥98,000 (税込¥107,800)

※組立式



Ash



Toffee





BASED-WIZ 2P BENCH

ベースドウィズ 2P ベンチ

Code 282695 (Ash) 282701 (Toffee)
Size W1200 D600 H720 SH430
Material Fabric, Steel
Price ¥49,000 (税込¥53,900)



Ash



Toffee

BASED-WIZ



BASED-WIZ MOVER CHAIR

ベースドウィズ ムーバー チェア

Code 286822'
 Size W480 D650 H760 SH430
 Material Fabric, Steel, PU caster
 Price ¥69,000 (税込¥75,900)



BASED-WIZ MOVER STOOL

ベースドウィズ ムーバー スツール

Code 286839'
 Size W510 D510 H430
 Material Fabric, Steel, PU caster
 Price ¥50,000 (税込¥55,000)



SELECTED ORDER

各アイテムごとの張地パリエーションから、色をお選びいただけます。ご注文の際は、各製品ごとの品番を用いて、張地色をお知らせください。

BASED-WIZ PERSONAL DESK SELECTED

Size W1000 D700 H1400 TH720
Material Fabric, Steel, Melamine
Price ¥225,000 (税込¥247,500)



BW-PD-285702-BLP-BRP

品番: BW - PD - 285702 - ○○○ - △△△

※○○○ = パネル外側色品番 / △△△ = パネル内側色品番
※色品番は各色()をご参照ください

PANEL COLOR Material: 再生ポリエステル100% (RENU®28%使用)



Black
(BKP)

Sand grey
(SGP)

Brown
(BRP)

Blue
(BLP)

Green
(GRP)



※パイピングは白のみとなります

BASED-WIZ PERSONAL SOFA SELECTED

Size W1000 D700 H1400 SH430
Material Fabric, Steel
Price ¥270,000 (税込¥297,000)



BW-PS-285795-BKP-BKP-MGS

品番: BW - PS - 285795 - ○○○ - △△△ - □□□

※○○○ = パネル外側色品番 / △△△ = パネル内側色品番 / □□□ = シート色品番
※色品番は各色()をご参照ください

PANEL COLOR Material: 再生ポリエステル100% (RENU®28%使用)

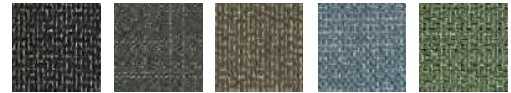

Black
(BKP)

Sand grey
(SGP)

Brown
(BRP)

Blue
(BLP)

Green
(GRP)

SEAT COLOR Material: PVC (抗菌仕様)



Black
(BKS)

IVORY
(IVS)

Dark grey
(DGS)

Medium grey
(MGS)

Sweep grey
(SGS)

BASED-WIZ BOOTH SOFA SELECTED

Size W1400 D700 H1100 SH450
Material Fabric, Steel
Price ¥193,000 (税込¥212,300)



BW-BS-285764-YE

品番: BW - BS - 285764 - ○○

※○○ = シート色品番

※色品番は各色()をご参照ください / シート色は背座共通です

SEAT COLOR Material: 再生ポリエステル100%



Yellow
(YE)

Dark green
(DG)

Grey mint
(GM)

Dark blue
(DB)

Pas grey
(PG)

FLEX-WIZ

BASED-WIZ 2P BENCH SELECTED

Size W1200 D600 H720 SH430
 Material Fabric, Steel
 Price ¥120,000 (税込¥132,000)



BW-2P-285733-DG

品番: BW - 2P - 285733 - ○○

※○○ = シート色品番

※色品番は各色()をご参照ください / シート色は背座共通です

SEAT COLOR Material: 再生ポリエステル100%



Yellow
(YE)

Dark green
(DG)

Grey mint
(GM)

Dark blue
(DB)

Pas grey
(PG)

BASED-WIZ MOVER CHAIR SELECTED

Size W480 D650 H760 SH430
 Material Fabric, Steel, PU caster
 Price ¥79,000 (税込¥86,900)



BW-MC-285849-GM

品番: BW - MC - 285849 - ○○

※○○ = シート色品番

※色品番は各色()をご参照ください / シート色は背座共通です

SEAT COLOR Material: 再生ポリエステル100%



Yellow
(YE)

Dark green
(DG)

Grey mint
(GM)

Dark blue
(DB)

Pas grey
(PG)

BASED-WIZ MOVER STOOL SELECTED

Size W510 D510 H430
 Material Fabric, Steel, PU caster
 Price ¥59,000 (税込¥64,900)



BW-MS-285856-DB

品番: BW - MS - 285856 - ○○

※○○ = シート色品番

※色品番は各色()をご参照ください

SEAT COLOR Material: 再生ポリエステル100%



Yellow
(YE)

Dark green
(DG)

Grey mint
(GM)

Dark blue
(DB)

Pas grey
(PG)



BASED-WIZ



BASED-WIZ SWALLOW DESK

ベースドウィズ スワロー デスク

Code 286761
 Size W1200 D625/1200 H720
 Material Melamine, Steel, Nylon caster
 Price ¥55,000 (税込¥60,500)

※Special price

※組立式

※2WAY仕様



BASED-WIZ MOBILE DESK

ベースドウィズ モバイル デスク

Code 286778
 Size W1200 D600 H720
 Material Melamine, Steel, Nylon caster
 Price ¥29,000 (税込¥31,900)

※Special price

※組立式





BASED-WIZ



BASED-WIZ LOCKER OPEN

ベースドウィズ ロッカー オープン

Code 280035
Size W400 D400 H830
Material Melamine
Price ¥25,000 (税込¥27,500)

※Special price

※可動棚付き

※上下左右連結可能



BASED-WIZ LOCKER 1 DOOR

ベースドウィズ ロッカー 1 ドア

Code 280042
Size W400 D420 H830
Material Melamine
Price ¥33,000 (税込¥36,300)

※Special price

※可動棚付き

※上下左右連結可能



BASED-WIZ LOCKER 2 DOOR

ベースドウィズ ロッカー 2 ドア

Code 280059
Size W400 D420 H830
Material Melamine
Price ¥39,000 (税込¥42,900)

※Special price

※上下左右連結可能



Black



White

OHANA POT

オハナ ポット

Code 283517 (Black) 283524 (White)

Size Φ 166 H260/330

Material Polypropylene, Beech wood

Price ¥12,000 (税込¥13,200)

※2WAY仕様



Black



White



KOA WAGON

コア ワゴン

Code 283494 (Black) 283500 (White)

Size W600 D370 H590

Material ABS, Beech wood, Steel, PP caster

Price ¥18,000 (税込¥19,800)

※組立式

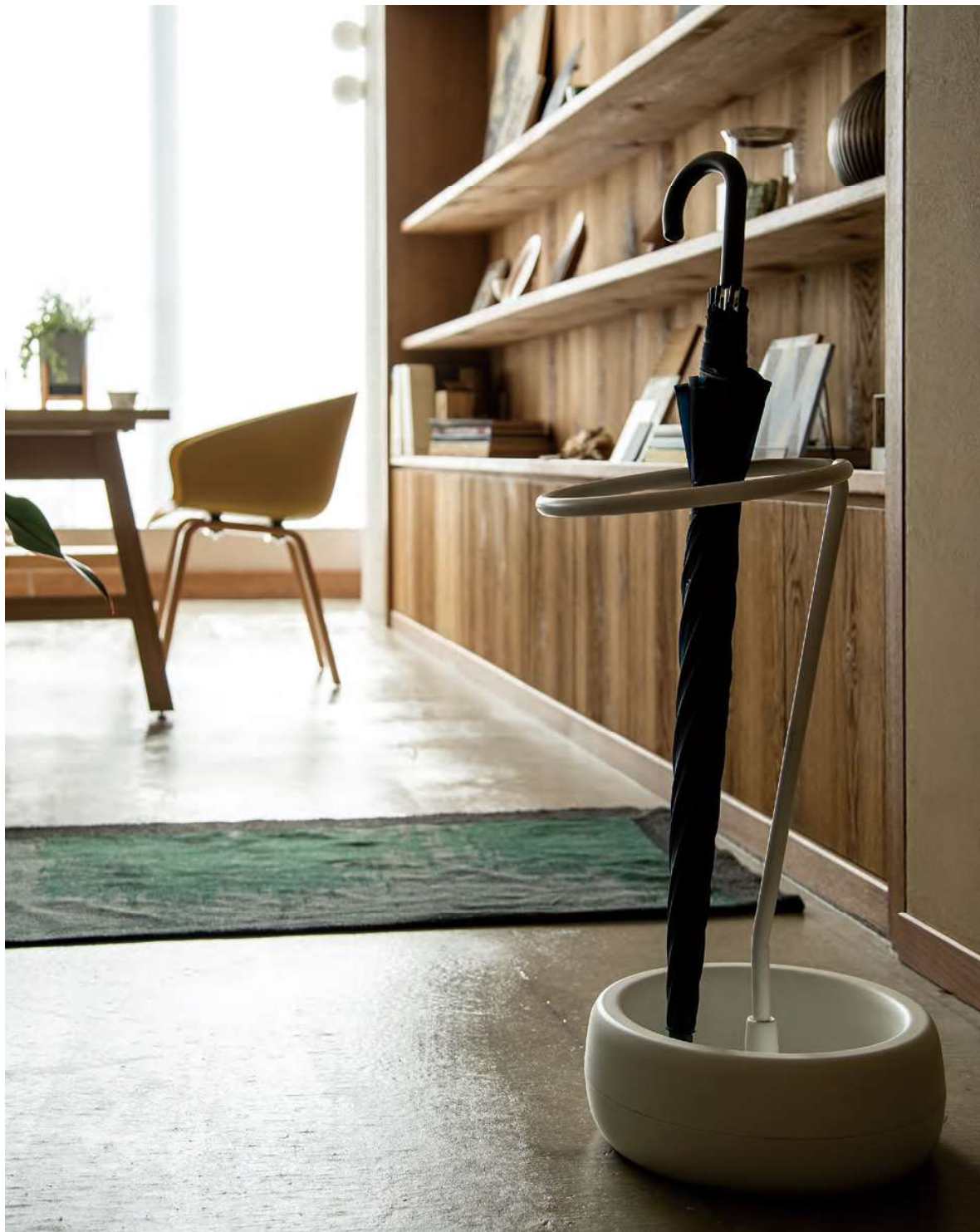

KILI UMBRELLA STAND

キリ アンブレラ スタンド

Code 501642 (Black) 501659 (White)
Size Φ 300 H600
Material Steel, Polypropylene
Price ¥15,000 (税込¥16,500)



Black



White

And-PluS

Timeless value - 時空を超えた価値 -

色あせることなく長く愛されるもの。伝統の中にある革新性。そのままの心地よさ。
こうした様々な思いのもと、国内外のアイテムを幅広く展開してきた『ASPLUND』。
何気ない日常の中に、驚きと感動、そして最上の快適さを紡いでいきます。



 emu [emu.it](https://www.emu.it)

画期的なデザイン、優れた機能性、洗練されたマテリアルの組み合わせ。

emu(エミュー)は70年近くにわたり、イタリアはペルージャでアウトドアファニチャーを製造してきました。

製品の品質と信頼性へのこだわり、職人のノウハウ、先進技術と革新的スタイルの追求、

イタリア国内外のデザイナーとのコラボレーションにより、年間約45万台の製品を世界85ヶ国へ供給する、

世界的ファニチャーブランドとしてトレンドを絶え間なく創出し続けています。



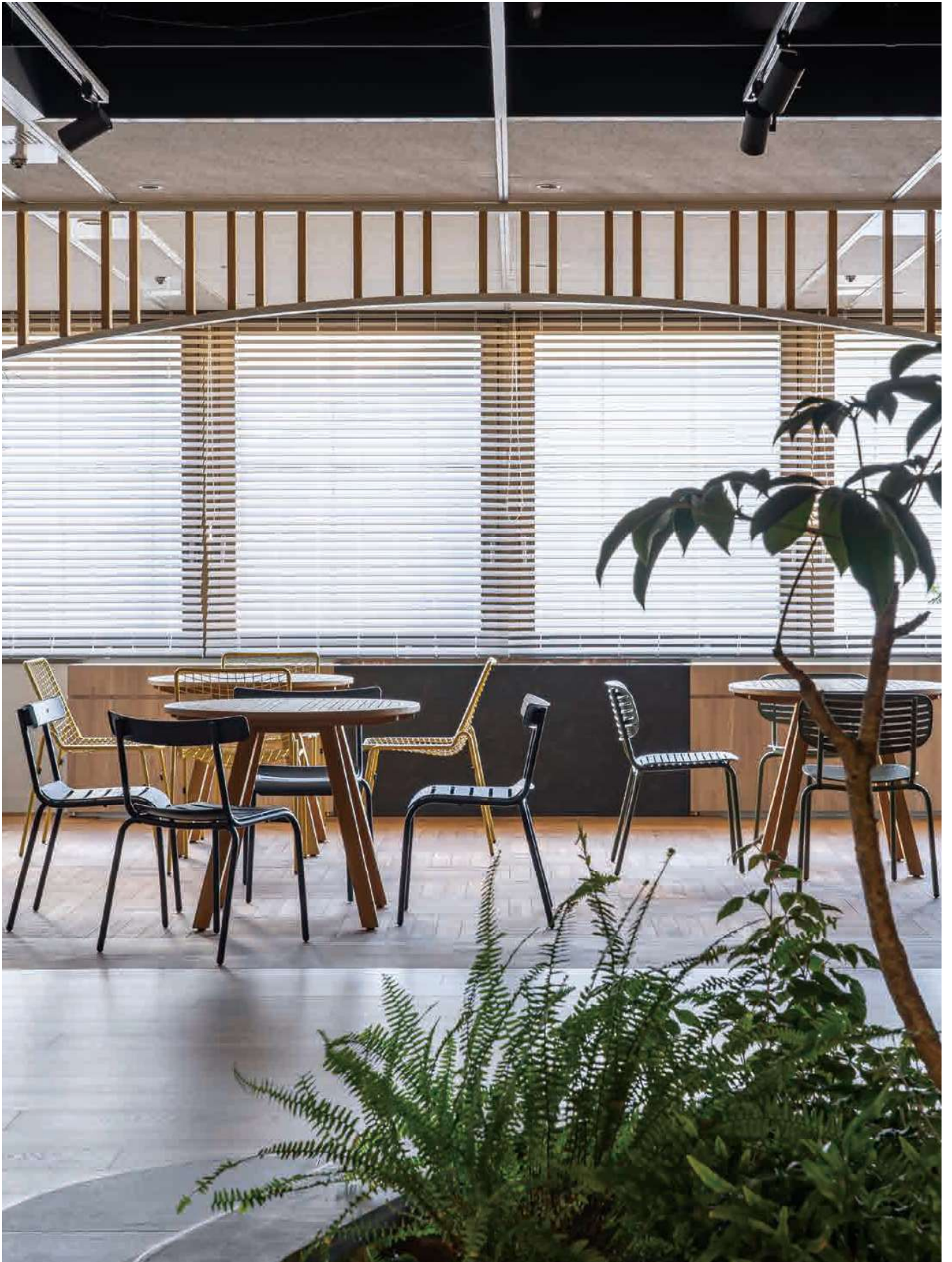



□ MIKY SIDE CHAIR DBL  

ミキー サイド チェア DBL

DESIGNED by FLORENT COIRIER

Code 927107

Size W560 D550 H770 SH450

Material Steel

Price ¥28,000 (税込¥30,800)

※スタッキング4脚まで可能



□ MOM SIDE CHAIR  

ママ サイド チェア

DESIGNED by FLORENT COIRIER

Code 906294

Size W530 D550 H770 SH460

Material Steel

Price ¥32,000 (税込¥35,200)

※スタッキング4脚まで可能



□ RIO R50 SIDE CHAIR  

リオ R50 サイド チェア

DESIGNED by EMANUEL GARGANO / ANTON CRISTELL

Code 906287

Size W530 D600 H850 SH450

Material Steel

Price ¥32,000 (税込¥35,200)

※スタッキング4脚まで可能



□ THOR CHAIR  

トール チェア

DESIGNED by CHIARAMONTE-MARIN

Code 941431

Size W520 D510 H800 SH450

Material Steel

Price ¥32,000 (税込¥35,200)

※スタッキング4脚まで可能





□ RIVIERA SIDE CHAIR

リヴィエラ サイド チェア

DESIGNED by LUCIDI-PEVERE

Code 954516
 Size W500 D570 H780 SH460
 Material Steel
 Price ¥42,000 (税込¥46,200)

※スタッキング4脚まで可能



□ RIVIERA BAR STOOL

リヴィエラ バー スツール

DESIGNED by LUCIDI-PEVERE

Code 954523
 Size W550 D530 H960 SH750
 Material Steel
 Price ¥54,000 (税込¥59,400)

※スタッキング4脚まで可能



□ THOR STOOL

トール スツール

DESIGNED by CHIARAMONTE-MARIN

Code 906300
 Size W470 D470 H450
 Material Steel
 Price ¥30,000 (税込¥33,000)

※スタッキング4脚まで可能



□ THOR BAR STOOL

トール バー スツール

DESIGNED by CHIARAMONTE-MARIN

Code 941448
 Size W470 D470 H750
 Material Steel
 Price ¥35,000 (税込¥38,500)

※スタッキング4脚まで可能

□ TERRAMARE SMART TABLE

テラマーレ スマート テーブル

DESIGNED by CHIARAMONTE-MARIN

Code 928906 (Nero black) 928890 (Cement)
 Size W650 D490 H470~710
 Material Aluminum
 Price ¥60,000 (税込¥66,000)

※昇降式



Nero black



Cement

VINCENT SHEPPARD

vincent sheppard.com

スチールワイヤーにクラフト紙を巻き付けて織り上げるロイドルームと呼ばれる技法を、

時代にあわせて進化させてきたVINCENT SHEPPARD(ヴィンセント・シェパード)。

20世紀初頭より続く伝統的な技法をベースに、現代的な感覚を持った新たな家具たちを生み出し続けています。

VINCENT SHEPPARDが演出する空間には、やさしさと美しさが同居し、心地よい時間が流れます。









AVRIL SWIVEL CHAIR

アヴリル スイベル チェア

Size W580 D560 H740 SH440

Material Paper wicker, Aluminum,
Die-cast aluminum

Price ¥58,000 (税込¥63,800)



Black



Silver

AVRIL CASTER CHAIR

アヴリル キャスター チェア

Size W580 D560 H740 SH440

Material Paper wicker, Aluminum,
Die-cast aluminum, Nylon caster

Price ¥65,000 (税込¥71,500)



Black



Silver

YANN SWIVEL CHAIR

ヤン スイベル チェア

Size W480 D550 H840 SH440

Material Paper wicker, Aluminum,
Die-cast aluminum

Price ¥58,000 (税込¥63,800)



Black



Silver

YANN CASTER CHAIR

ヤン キャスター チェア

Size W480 D550 H840 SH440

Material Paper wicker, Aluminum,
Die-cast aluminum, Nylon caster

Price ¥65,000 (税込¥71,500)



Black



Silver



□ TITUS LOUNGE CHAIR

タイタス ラウンジ チェア

Code 929002
Size W700 D700 H730 SH410 AH580
Material Oak wood, Rattan, Vinyl leather
Price ¥180,000 (税込¥198,000)



□ FRIDA LOUNGE CHAIR

フリーダ ラウンジ チェア

Code 944487
Size W910 D810 H800 SH390
Material Teak wood, PP rope
Price ¥220,000 (税込¥242,000)

□ ROXANNE LAZY CHAIR

ロクサーヌ レイジー チェア

Code 928920
Size W700 D650 H730 SH420
Material Polypropylene wicker, Aluminum, Steel
Price ¥52,000 (税込¥57,200)



□ OLAF OUTDOOR POUFFE L MINERAL BLUE

オラフ アウトドア プフ L ミネラル ブルー

Code 929019
Size Φ780 H520
Material Fabric (Acrylic/Sunbrella)
Polyester, Polystyrene beads
Price ¥135,000 (税込¥148,500)



□ OLAF OUTDOOR POUFFE S BLUSH

オラフ アウトドア プフ S ブラッシュ

Code 929033
Size Φ470 H460
Material Fabric (Acrylic/Sunbrella)
Polyester, Polystyrene beads
Price ¥92,000 (税込¥101,200)



□ OLAF OUTDOOR POUFFE S LONDON STONE

オラフ アウトドア プフ S ロンドン ストーン

Code 929026
Size Φ470 H460
Material Fabric (Acrylic/Sunbrella)
Polyester, Polystyrene beads
Price ¥92,000 (税込¥101,200)

※雨に長時間さらされると、縫い目等から雨水が浸透し、中材が乾きにくくなり劣化やカビ発生の原因になります。
雨天の際は軒下へ収納することをお勧めします。

ハンドメイドとサステナビリティを哲学とし、時代を超えた家具を創出し続けているdareels(ダリールズ)。インドネシア・ジャワ島の古い建物や倉庫で使用されていたチークウッドを再利用し、自然素材が織りなす唯一無二の家具を展開しています。家具を通じて自然を感じることのできるdareelsは、空間と心にやすらぎをもたらします。







NEW JATI CIRCLE 110

DINING TABLE

ニュー ジャティ サークル 110 ダイニング テーブル

Code 135717
Size Φ 1100 H730
Material Old teak wood, Steel
Price ¥178,000 (税込¥195,800)
※組立式



YE 160 DINING TABLE

YE 160 ダイニング テーブル

Code 131795
Size W1600 D800 H720
Material Old teak wood, Steel
Price ¥109,000 (税込¥119,900)
※組立式



YE 140 DINING TABLE

YE 140 ダイニング テーブル

Code 128979
Size W1400 D800 H720
Material Old teak wood, Steel
Price ¥99,000 (税込¥108,900)
※組立式

YE HIGH COFFEE TABLE

YE ハイ コーヒー テーブル

Code 128986
Size W1050 D500 H550
Material Old teak wood, Steel
Price ¥59,000 (税込¥64,900)
※組立式

※ハンドメイド、天然素材を使用しているため、一品ごとに仕上がりが異なります



TOOR COFFEE TABLE ⇄

トアー コーヒー テーブル

Code 131856
Size Φ900 H400
Material Old teak wood, Glass
Price ¥98,000 (税込¥107,800)



TOOR SIDE TABLE ⇄

トアー サイド テーブル

Code 132884
Size Φ400 H500
Material Old teak wood, Glass
Price ¥48,000 (税込¥52,800)



TOOR STOOL ⇄

トアー スツール

Code 128900
Size W300 D300 H400
Material Old teak wood
Price ¥30,000 (税込¥33,000)



TOOR STOOL SQUARE ⇄

トアー スツール スクエア

Code 128917
Size W300 D300 H450
Material Old teak wood
Price ¥42,000 (税込¥46,200)



TOOR STOOL ROUND ⇄

トアー スツール ラウンド

Code 128924
Size Φ300 H450
Material Old teak wood
Price ¥40,000 (税込¥44,000)

ONE TWO RECT SIDE TABLE ⇄

ワントゥ レクト サイド テーブル

Code 127170
Size W310 D460 H500
Material Old teak wood, Steel
Price ¥22,000 (税込¥24,200)



※ハンドメイド、天然素材を使用しているため、一品ごとに仕上がりが異なります



JOURNAL STANDARD FURNITURE

ファッションの視点を通じて生み出される、

JOURNAL STANDARD FURNITURE(ジャーナル スタンダード ファニチャー)の家具たち。

ヴィンテージ感があるデザインの中に、トレンドとセンスを加えた独自の世界観。

インテリアとファッションの融合から生まれる空間には、ライフスタイルを豊かにする要素が溢れています。





And-PluS



COMPASS LEG DESK NATURAL

コンパス レッグ デスク ナチュラル

Code 275499
Size W1200 D600 H720
Material Pine wood, Plywood, Steel
Price ¥24,000 (税込¥26,400)

※Special price

※組立式



COMPASS LEG DESK BLACK

コンパス レッグ デスク ブラック

Code 275260
Size W1200 D600 H720
Material Melamine, Plywood, Steel
Price ¥24,000 (税込¥26,400)

※Special price

※組立式



COMPASS LEG DESK IVORY

コンパス レッグ デスク アイボリー

Code 283159
Size W1200 D600 H720
Material Melamine, Steel
Price ¥24,000 (税込¥26,400)

※Special price

※組立式



COMPASS LEG DESK GREIGE

コンパス レッグ デスク グレージュ

Code 283166
Size W1200 D600 H720
Material Melamine, Steel
Price ¥24,000 (税込¥26,400)

※Special price

※組立式



OPTION

コンセント

Code 275062
Size W97 D29 H26
Price ¥2,000 (税込¥2,200)



※天板により、切り欠き形状が異なります

JSF TASK CHAIR

JSF タスク チェア

Code 274980
Size W560 D580 H755~860 SH395~500 AH590~695
Material Steel, Plywood, PVC
Price ¥29,000 (税込¥31,900)

※組立式



JSF WOODEN LOCKER 3 DOOR

JSF ウッデン ロッカー 3 ドア

Size W430 D460 H1130
Material Pine wood, Plywood, Printed paper board
Price ¥32,000 (税込¥35,200)

※Special price

※組立式



3 DOOR



5 DOOR

JSF WOODEN LOCKER 5 DOOR

JSF ウッデン ロッカー 5 ドア

Size W430 D460 H1775
Material Pine wood, Plywood, Printed paper board
Price ¥50,000 (税込¥55,000)

※Special price

※組立式

JSF WOODEN LOCKER 6 DOOR

JSF ウッデン ロッカー 6 ドア

Size W850 D460 H1130
Material Pine wood, Plywood, Printed paper board
Price ¥38,000 (税込¥41,800)

※Special price

※組立式



6 DOOR



CABINET

JSF WOODEN CABINET

JSF ウッデン キャビネット

Size W850 D460 H1130
Material Pine wood, Plywood, Printed paper board
Price ¥35,000 (税込¥38,500)

※Special price

※組立式

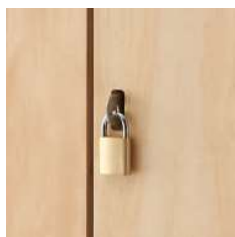

※南京錠が使用できます
(南京錠は付属しておりません)





ARMLESS × 1 / CORNER × 1 / BENCH 800 × 1



FIELD SOFA ARMLESS

フィールド ソファ アームレス

Code 275406
 Size W650 D800 H700 SH400
 Material Cotton, Polyester, Steel
 Price ¥42,000 (税込¥46,200)

※Special price



FIELD SOFA CORNER

フィールド ソファ コーナー

Code 275390
 Size W800 D800 H700 SH400
 Material Cotton, Polyester, Steel
 Price ¥49,000 (税込¥74,800)

※Special price



FIELD SOFA BENCH 1600

フィールド ソファ ベンチ 1600

Code 275420
 Size W1600 D500 H400
 Material Cotton, Polyester, Steel
 Price ¥35,000 (税込¥38,500)

※Special price



FIELD SOFA BENCH 800

フィールド ソファ ベンチ 800

Code 275413
 Size W800 D500 H400
 Material Cotton, Polyester, Steel
 Price ¥25,000 (税込¥27,500)

※Special price



ARMLESS × 1 / CORNER × 1 / OTTOMAN × 1



BLOCK SOFA ARMLESS

ブロック ソファ アームレス

Code 275369
 Size W900 D900 H620 SH350
 Material Polyester
 Price ¥20,000 (税込¥22,000)

※Special price



BLOCK SOFA CORNER

ブロック ソファ コーナー

Code 275352
 Size W900 D900 H620 SH350
 Material Polyester
 Price ¥25,000 (税込¥27,500)

※Special price



BLOCK SOFA OTTOMAN

ブロック ソファ オットマン

Code 275376
 Size W900 D900 H350
 Material Polyester
 Price ¥15,000 (税込¥16,500)

※Special price



BLOCK SOFA SINGLE ARM

ブロック ソファ シングル アーム

Code 275383
 Size W450 D450 H620
 Material Polyester
 Price ¥10,000 (税込¥11,000)

※Special price



JSF SOFA WORK TABLE

JSF ソファ ワーク テーブル

Code 275345
 Size W300 D450 H600
 Material Steel, Plywood
 Price ¥12,000 (税込¥13,200)

※Special price

※組立式



OPTION

コンセント

Code 275062
 Size W97 D29 H26
 Price ¥2,000 (税込¥2,200)

SET PATTERN

JUNGLE GYM SHELF SET 5×3

ジャングルジム シェルフ セット 5×3

Size W1220 D400 H2025
Material Steel, Pine wood, Plywood
Price ¥123,000 (税込¥135,300)
※組立式



5 TIER × 1pcs
5 ADD ON × 2pcs
BOARD × 18pcs (3set)

JUNGLE GYM SHELF SET 3×3

ジャングルジム シェルフ セット 3×3

Size W1220 D400 H1235
Material Steel, Pine wood, Plywood
Price ¥90,000 (税込¥99,000)
※組立式



3 TIER × 1pcs
3 ADD ON × 2pcs
BOARD × 12pcs (2set)



5 TIER



5 ADD ON

JUNGLE GYM SHELF 5 TIER

ジャングルジム シェルフ 5 ティア

Code 275192
 Size W420 D400 H2025
 Material Steel
 Price ¥25,000 (税込¥27,500)
 ※組立式



3 TIER



3 ADD ON

JUNGLE GYM SHELF 3 TIER

ジャングルジム シェルフ 3 ティア

Code 275215
 Size W420 D400 H1235
 Material Steel
 Price ¥20,000 (税込¥22,000)
 ※組立式

JUNGLE GYM SHELF 5 ADD ON

ジャングルジム シェルフ 5 アドオン

Code 275208
 Size W400 D400 H2025
 Material Steel
 Price ¥22,000 (税込¥24,200)
 ※組立式

JUNGLE GYM SHELF 3 ADD ON

ジャングルジム シェルフ 3 アドオン

Code 275222
 Size W400 D400 H1235
 Material Steel
 Price ¥17,000 (税込¥18,700)
 ※組立式



JUNGLE GYM SHELF SAFETY BOX

ジャングルジム シェルフ セーフティ ボックス

Code 285672
 Size W375 D400 H375
 Material Pine wood, Plywood
 Price ¥23,000 (税込¥25,300)



JUNGLE GYM SHELF BOX

ジャングルジム シェルフ ボックス

Code 275246
 Size W375 D400 H375
 Material Pine wood, Plywood
 Price ¥13,000 (税込¥14,300) ×2pcs
 ※販売単位は2pcs (1set) です



JUNGLE GYM SHELF BOARD

ジャングルジム シェルフ ボード

Code 275239
 Size W375 D400 H25
 Material Pine wood, Plywood
 Price ¥3,000 (税込¥3,300) ×6pcs
 ※販売単位は6pcs (1set) です

Work Plus SUSTAINABLE



Natures cast®

森林農業などの過程で生じる
小枝や樹皮などの農業廃棄物を使用した、
サステナブル素材の Natures cast®（ネイチャーズキャスト）。
2014 年以來、4.43 トンをアップサイクルしており、
2020 年、Cradle to Cradle（C2C）認証を取得。
MATERIAL HEALTH の最高評価を達成しました。



PANECO®

世界中で年間約 9,200 万トンとも言われる
深刻なファッションロス。
廃棄衣類品に含まれる様々な繊維を原料とした
PANECO®（パネコ）は、
家具やディスプレイのデザインの視点から
環境問題に取り組んできました。
また、使用後の PANECO® を回収し、
再びボードとしてリサイクルすることで、
持続可能な脱廃棄社会をめざしていきます。



OLTREMATERIA®

イタリアで開発された、左官仕上材の OLTREMATERIA® (オルトレマテリア)。
鏝 (コテ) を用いた表情豊かな仕上がりは、デザイン性の高い空間を演出します。
二酸化炭素排出量の少ないアクリル樹脂を主材としながら、
ひまわり油由来のポリマーを 20% 配合することで、サステナブルな要素も併せ持ちます。
また、国際的な食品衛生管理基準である HACCP (ハサップ) にも対応しており、
衛生面でも安心してご使用いただけます。



JAPAN BLUE 藍

日本最古の染料であるといわれる藍。
寒色でありながら深みと温かみを感じる藍色は、
世界各国でジャパン・ブルーと呼ばれ、長年愛され続けています。



JAPAN RED 弁柄

人類が最初に作った赤色の顔料といわれる弁柄。
日本が誇る様々な伝統工芸品に用いられてきた弁柄色は、
格式高く、馴染み深い、特別な色として認知されています。





NOVA PENDANT BR ⇄

ノヴァ ペンダント BR

Code 933580
 Size Φ200 H380 2kg
 Material Natures cast®
 LED 電球 (E26/7.5W × 1灯)
 Price ¥25,000 (税込¥27,500)



NOVA PENDANT SB ⇄

ノヴァ ペンダント SB

Code 933566
 Size Φ180 H280 1kg
 Material Natures cast®
 LED 電球 (E26/7.5W × 1灯)
 Price ¥21,000 (税込¥23,100)



NOVA PENDANT IV ⇄

ノヴァ ペンダント IV

Code 933542
 Size Φ170 H230 1kg
 Material Natures cast®
 LED 電球 (E26/7.5W × 1灯)
 Price ¥19,000 (税込¥20,900)



※各種吊り下げ照明には左図のコード収納式フランジ (引掛けシーリング方式) が付属しています。
 ※天井器具から器具シェード取付部分まで、約100~970mmの範囲で調整できます。



NEW ORB COFFEE TABLE ⇄

ニュー オープ コーヒー テーブル

Code 906850
 Size Φ800 H400
 Material Natures cast®, FRP
 Price ¥68,000 (税込¥74,800)



NEW ORB SIDE TABLE ⇄

ニュー オープ サイド テーブル

Code 906867
 Size Φ550 H600
 Material Natures cast®, FRP
 Price ¥55,000 (税込¥60,500)



NEW ORB STOOL ⇄

ニュー オープ スツール

Code 906874
 Size Φ340 H430
 Material Natures cast®, FRP
 Price ¥34,000 (税込¥37,400)



And-PluS

□ NOB SIDE TABLE ⇄

ノブ サイド テーブル

Size W500 D510 H550

Material PANECO®, Steel

Price ¥124,000 (税込¥136,400)



□ NOB COFFEE TABLE ⇄

ノブ コーヒー テーブル

Size W800 D800 H380

Material PANECO®, Steel

Price ¥139,000 (税込¥152,900)





TROWEL RECTANGLE TABLE TOP

トロウエル テーブルトップ

Material OLTREMATERIA®

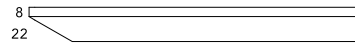

Size	Price
W1600 D1000 t30	¥260,000 (税込¥286,000)
W1800 D1000 t30	¥285,000 (税込¥313,500)
W2000 D1000 t30	¥310,000 (税込¥341,000)

※テーブル天板のみの価格です。
テーブル脚はP.23「FLEX-WIZ FREE ADDRESS DESK END LEG」よりご選定ください。

TABLE TOP COLOR

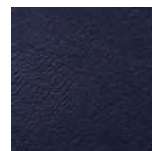

JAPAN BLUE

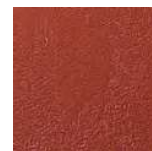

JAPAN RED



JAPAN GREY

OPTION

配線キャップ

Code 280868
Size W200 D125
Price ¥31,000 (税込¥34,100)

※本製品の配線キャップにブラシは付属しません。



OPTION



TROWEL ROUND TABLE

トロウエル ラウンド テーブル

Material OLTREMATERIA®

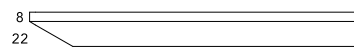

Size	Price
Φ 900 H720	¥265,000 (税込¥291,500)
Φ 1000 H720	¥278,000 (税込¥305,800)
Φ 1100 H720	¥290,000 (税込¥319,000)
Φ 1200 H720	¥300,000 (税込¥333,000)

※組立式
 ※テーブル天板・脚のセット価格です。いずれか一方での販売はございません。
 ※配線キャップをご希望の場合は、P.128よりご選定ください。

TABLE TOP COLOR



JAPAN BLUE

JAPAN RED

JAPAN GREY

TABLE LEG COLOR



Natural

Black

PHOTO INDEX

CASTER CHAIR

LIAN CHAIR > P.16 RONAL CHAIR > P.18 MARBRIC CHAIR > P.04 VIVY CHAIR > P.06 PLUME CHAIR > P.08 JSF TASK CHAIR > P.117 OCUS CHAIR > P.10



MOONO CHAIR > P.76 AVRIL CASTER CHAIR > P.106 CORITO CHAIR > P.76 KANOA CASTER CHAIR > P.70 BASED-WIZ MOVER CHAIR > P.85 YANN CASTER CHAIR > P.106



ARM CHAIR / SIDE CHAIR

LEHUA CHAIR > P.74 MAYUKU ARM CHAIR > P.66 HOAKA CHAIR > P.68 AVRIL SWIVEL CHAIR > P.106 OLU CHAIR > P.74 NORUN CHAIR > P.72 YANN SWIVEL CHAIR > P.106



RIO R50 SIDE CHAIR > P.100 MOM SIDE CHAIR > P.100 RIVIERA SIDE CHAIR > P.101 MIKY SIDE CHAIR DBL > P.100 THOR CHAIR > P.100



LOUNGE CHAIR

MAYUKU LOUNGE CHAIR > P.66 TITUS LOUNGE CHAIR > P.107 LINO LOUNGE CHAIR > P.78 BASED-WIZ PERSONAL SOFA > P.81 ROXANNE LAZY CHAIR > P.107 FRIDA LOUNGE CHAIR > P.107



COUNTER CHAIR

COPPO HIGH CHAIR > P.12 MAYUKU BAR STOOL > P.66 RIVIERA BAR STOOL > P.101 THOR BAR STOOL > P.101



STOOL

BASED-WIZ MOVER STOOL > P.85 LAPULE 1P OTTOMAN > P.78 NEW ORB STOOL > P.125 TOOR STOOL > P.111 TOOR STOOL SQUARE > P.111 TOOR STOOL ROUND > P.111 THOR STOOL > P.101



SOFA / OTTOMAN

BLOCK SOFA > P.119 FIELD SOFA > P.118 BASED-WIZ BOOTH SOFA > P.82 BASED-WIZ 2P BENCH > P.84



MALU-TUBE 2P SOFA > P.64 MALU-TUBE 1P SOFA > P.64 OLAF OUTDOOR POUFFE L > P.107 OLAF OUTDOOR POUFFE S > P.107



PERSONAL BOOTH

COCOON BOOTH
> P.56
C



BASED-WIZ
PERSONAL DESK
> P.80
C



DESK TABLE

FLEX-WIZ FREE ADDRESS DESK
> P.22
C <=>



FLEX-WIZ FUNCTIONAL DESK
> P.34
C <=>



FLEX-WIZ HUDDLE
CASTER DESK
> P.36
C <=>



FLEX-WIZ BOOTH
MEET DESK
> P.38
C <=>



FLEX-WIZ
MULTI DESK
> P.28
C <=>



COMPASS LEG
DESK
> P.116
C



BASED-WIZ
MOBILE DESK
> P.88

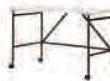

BASED-WIZ
SWALLOW
DESK
> P.88



YE
DINING TABLE
> P.110
<=>



NEW JATI
CIRCLE110
DINING TABLE
> P.110 <=>



TROWEL
ROUND TABLE
> P.129
<=>



**LOW TABLE /
COUNTER TABLE**

NEW ORB
COFFEE TABLE
> P.125
<=>



NEW ORB
SIDE TABLE
> P.125
<=>



NOB
COFFEE TABLE
> P.126
<=>



NOB
SIDE TABLE
> P.126
<=>



JSF
SOFA WORK
TABLE
> P.119



ONE TWO
RECT SIDE TABLE
> P.111
<=>



YE
HIGH COFFEE
TABLE
> P.110 <=>



TOOR
COFFEE TABLE
> P.111
<=>



TOOR
SIDE TABLE
> P.111
<=>



TERRAMARE
SMART TABLE
> P.101
C



FLEX-WIZ COUNTER DESK
> P.30
C <=>



STORAGE

FLEX-WIZ STORAGE
> P.42
C



BASED-WIZ LOCKER
> P.90



JSF WOODEN LOCKER
> P.117



FLEX-WIZ CABINET
> P.44



FLEX-WIZ PROD SHELF
> P.46
<=>



JUNGLE GYM SHELF
> P.120



ACCESSORY

FLEX-WIZ DESKTOP PANEL
FELT
> P.52



FLEX-WIZ DESKTOP PANEL
ACRYLIC
> P.52



FLEX-WIZ
WHITE BOARD L
> P.52



FLEX-WIZ
LINO DESK MAT
> P.50
C <=>



KOA WAGON
> P.92
C



OHANA POT
> P.92
C



NOVA PENDANT
> P.124
<=>



KILI UMBRELLA
STAND
> P.93
C



FLEX-WIZ REVIVER CUSHION
> P.51
C <=>



株式会社アスブルンド

〒108-0073 東京都港区三田3-13-16 三田43MTビル5F

■ オフィス部

TEL 03-3769-0681 / FAX 03-3769-0682

E-mail: oem@asplund.co.jp

■ ライフスタイル部

TEL 03-3769-0788 / FAX 03-3769-0668

E-mail: import@asplund.co.jp

■ コントラクト部 東京本社

TEL 03-3769-0637 / FAX 03-5444-6733

E-mail: contract@asplund.co.jp

■ コントラクト部 大阪オフィス

〒550-0015 大阪府大阪市西区南堀江1-19-26 アスブルンドビル(タイムレスコンフォート南堀江店内)3F

TEL 06-6533-8623 / FAX 06-6533-8624

E-mail: contract-osaka@asplund.co.jp

■ SHOWROOM ASPLUND CONTRACT / SHOP ASPLUND

〒150-0022 東京都渋谷区恵比寿南3-5-7 デジタルゲートビル2F

TEL 03-5734-1840 / FAX 03-5734-1841



ご注文について

- ご注文の際は担当者まで FAX・メールにてお問い合わせください。
- ご注文後のキャンセルは、キャンセル料(製作実費など)が発生する場合がございますのでご注意ください。
- 表示価格は2023年3月現在の商品価格です。送料・開梱設置等諸費用は別途お見積りいたします。
- 輸入品や受注生産品など納期がかかる商品がございます。担当者までお問い合わせください。

商品について

- 本カタログ掲載商品は2023年3月現在のものです。物価の変動、品質の改善などにより価格・寸法・仕様・カラーなどを予告なく変更させていただく場合がございます。あらかじめご了承ください。
- 生産ロットによりサイズ・重量・色に多少の差異が生じることがございます。あらかじめご了承ください。
- 本カタログ掲載商品の色調は、印刷上実物と多少の差異が生じることがございます。あらかじめご了承ください。
- 本カタログ掲載商品は、正しい使用状態の場合に限り、1年の保証期間を設定しております。
- ご使用環境により反りや割れ、変色などの経年変化を生じる場合があります。
- ハンドメイドや天然素材を使用している場合など、一品ごとに仕上がりが異なる場合がございます。

鍵について

- 万が一、鍵を紛失した場合は有料でご用意しております。担当者までお問い合わせください。
- 簡易施錠のため、貴重品の保管には十分ご注意ください。
紛失・盗難・破損などのトラブルについては、当社は一切の責任を負いません。あらかじめご了承ください。

お願い

- 商品が到着しましたら、ただちに点検をお願いします。万が一不良があった場合、また物流による破損が生じた場合は、速やかに担当者までご連絡ください。
- 本カタログに掲載されている情報(写真、文書、イラスト、ロゴなど)を複製、転用、販売など二次利用することをかたくお断りいたします。

■ 撮影協力

NARUMIYA INTERNATIONAL

■ Photographer

Keita Nishiyama

Tadashi Okuno

Ryo Hirayama

